

WHEEL END UNITS

COMMERCIAL VEHICLES

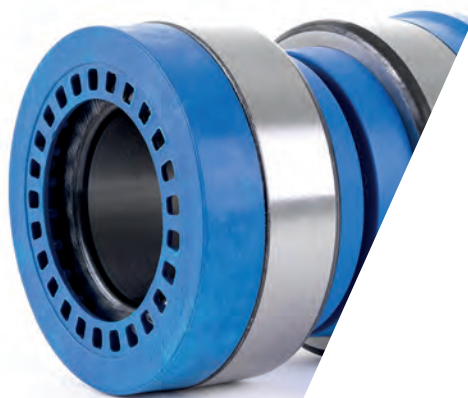

WHEEL END UNITS

COMMERCIAL VEHICLES

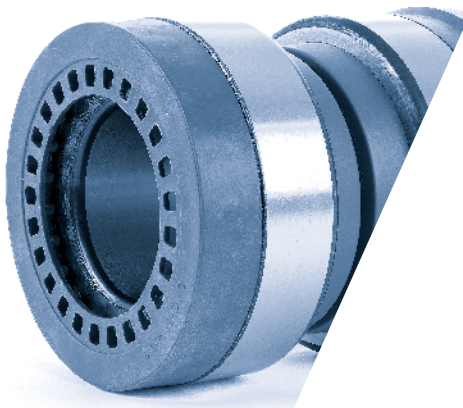
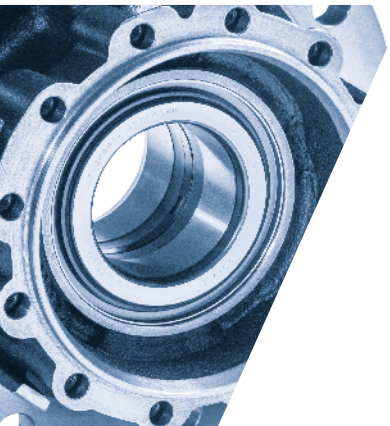

ABOUT US

FERSA BEARINGS IS A SPANISH MULTINATIONAL COMPANY DEDICATED TO THE DESIGN, DEVELOPMENT, MANUFACTURING AND DISTRIBUTION OF THE COMPLETE SOLUTIONS FOR HIGH PERFORMANCE BEARINGS

COMMERCIAL VEHICLE EXPERTS

The most complete range for major heavy vehicle applications.

As experts in bearings, we can offer specific bearing designs according to their final application: gearbox, differential and wheel ends.

We manufacture bearings for American, Asian and European vehicles.

Index

Índice

0 \	Technical introduction Introducción técnica	\5
1 \	Wheel end hub Hub de rueda	\6
2 \	Wheel end Kit Kit de rueda	\14
3 \	Wheel end module Modulo de rueda	\26
4 \	Preset hub assembly Rodamiento integral de rueda	\32
5 \	Wheel end complements Complementos para rueda	\36
	5.1 Grease \ Grasa	\38
	5.2 Fersa Tools \ Herramientas Fersa	\40
6 \	Cross reference Cruce de referencias	\42
	6.1 Competitor Cross References \ Cruce de Referencias con la competencia	\42
	6.2 OEM Cross References \ Cruce de Referencias OEM	\43



Introduction \ Introducción

Fersa's Hub Unit bearings for industrial vehicles are designed with one objective: to ensure maximum performance. This, together with an exhaustive quality control of all manufacturing processes, guarantees maximum durability of this maintenance free bearing.

All bearings are assembled in our specialized assembly line in the Zaragoza center, where 100% of production is verified, using the latest technological advances in R&D and quality control.

Our products are approved only after passing the most demanding trial and testing control programs in guarantee of our high technical and quality standards.

Los rodamientos para unidades de buje para vehículos industriales fabricados en Fersa Bearings son diseñados con un objetivo, conseguir la máxima eficiencia. Esto, acompañado de un exhaustivo control de calidad en los procesos de fabricación aseguran la máxima durabilidad del rodamiento libre de mantenimiento.

Los rodamientos son montados en nuestro centro especializado de montaje de Fersa en Zaragoza, garantizados con los más recientes avances tecnológicos en el área de I+D y calidad, donde se verifica el 100% de la producción.

Nuestro centro especializado de ensayos somete a los rodamientos a un exhaustivo programa de ensayos y pruebas antes de liberar el producto, garantizando nuestros altos estándares técnicos y de calidad.

Capacity \ Capacidades

Design for heavy loads at high speeds. Tapered roller bearings can support both axial and radial loads, allowing up to 0.06° of misalignment.

Equivalent dynamic load capacity (ISO 281): The axial balance of the shaft depends not only on the forces applied, but also on the forces induced by the radial loads applied on each bearing.

$$P = Fr + 1.1 Y * Fa \quad \text{si } Fa / Fr \leq e$$

$$P = 0.67 Fr + 1.68 Y * Fa \quad \text{si } Fa / Fr > e$$

Equivalent static load capacity: its value P0 is the greater of the two values obtained using the following formula:

$$P0 = Fr + Y0 * Fa$$

Están diseñados para grandes cargas a altas velocidades. Los rodamientos de rodillos cónicos, tienen una gran capacidad para resistir tanto cargas radiales como axiales, admitiendo des-alineamientos de 0.06°.

Capacidad de carga dinámica equivalente (ISO 281): El equilibrio axial del eje depende no sólo de las fuerzas aplicadas, sino también de las fuerzas inducidas por las cargas radiales aplicadas en cada rodamiento.

$$P = Fr + 1.1 Y * Fa \quad \text{si } Fa / Fr \leq e$$

$$P = 0.67 Fr + 1.68 Y * Fa \quad \text{si } Fa / Fr > e$$

Capacidad de carga estática equivalente: Su valor P0 es el mayor de los dos valores obtenidos aplicando la siguiente fórmula:

$$P0 = Fr + Y0 * Fa$$

Features \ Características

- The extended taper design bypasses the need for shims
- Reduced width tolerance
- Pre-adjusted distance between ring faces in the Wheel end Kit family to ensure optimal functioning.
- Control of axial clearance in Wheel end hub and Wheel end module bearing families.

- Diseño de conos extendidos que evitan el uso de espaciadores.
- Reducidas tolerancias de altura.
- Distancia pre-ajustada entre caras de aros para asegurar un óptimo funcionamiento en la familia Kit de rueda.
- Control de la holgura axial para los rodamientos de las familias Hub de rueda y Modulos de rueda.

Design \ Diseño

The internal clearance of Wheel end hub units is pre-adjusted by the manufacturer. The results are:

- No internal clearance produced from elastic deformations when applying load on the bearing.
- There is no offset of the shaft and rotation precision increases.
- Prevention of the fretting produced in the tracks because of external vibrations.

Reducing internal clearance is vital to the life of a bearing and a matter of analyses at each stage of the assembly process, as illustrated in the graph below.

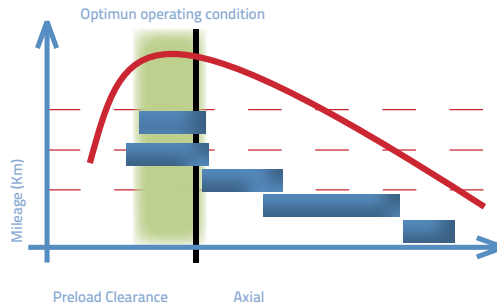

Las unidades de bujes vienen ajustadas de fábrica con un juego interno. Los efectos son:

- No se produce juego interno por deformaciones elásticas cuando se aplica carga sobre el rodamiento.
- Se evita el descentramiento del eje y la precisión de rotación es mayor.
- Se previene el fretting producido en la pista de rodadura por vibraciones externas.

La reducción del juego interno es crítica para la vida del rodamiento y se estudia en cada una de las etapas de montaje, como se muestra en el siguiente gráfico.

Lubrication \ Lubricación

Grease functions as a lubrication oil film between the rollers and the surface of the raceway preventing direct metal contact.

In Fersa we only use high quality grease in our pre-lubricated Wheel Hub Units, and we ensure that there is the correct amount and even distribution of grease in between all rollers.

La función de la grasa es crear una película lubricante de aceite entre los rodillos y la superficie de rodadura para prevenir el contacto directo entre metales.

En Fersa, hacemos las unidades de bujes pre-engrasadas de fábrica con grasa de alta calidad. Así aseguramos que contienen la cantidad correcta y una distribución uniforme entre todos los rodillos.

Sealing \ Estanqueidad

Wheel Hub Units come sealed from the manufacturer against three kinds of contamination:

- Seals between ring and taper against grease loss and contamination entry (oil, water, impurities...)
- O-rings in the internal taper against contamination from impurities entering through the stub shaft.
- Axial clamp seal between tapers in traction applications, sealing the bearing from the shaft oil bath.

Las unidades de bujes vienen selladas desde fábrica para evitar tres tipos de contaminación:

- Para evitar pérdida de grasa así como entrada de contaminación (aceite, agua, impurezas...) se colocan retenes entre el aro y el cono.
- Para impedir la entrada de impurezas a través de la mangueta se coloca una junta tórica en el cono interior.
- Para hacer el rodamiento estanco frente al baño de aceite del eje se coloca una junta axial entre los conos en las aplicaciones traccionadas.

1 \

WHEEL END HUB

HUB DE RUEDA

Introduction \ Introducción

The Fersa heavy-duty, Wheel end hub, bearings are a pre-set unit, made up of two inner rings housed by a single exterior cup. Due to its precise axial clearance, the compact and maintenance free design, as well as the use of high quality grease, we manage to obtain optimum performance while supporting extremely high loads.

Our Wheel end hubs guarantees quick and simple assembly.

Los rodamientos Fersa "Hub de rueda" son conjuntos preajustados, compuestos de 2 conjuntos interiores alojados en un solo aro exterior.

Debido a su precisa holgura axial, su diseño compacto y libre de mantenimiento y el uso de grasas de alta calidad, Fersa garantiza un óptimo funcionamiento del rodamiento a cargas elevadas.

Con nuestros hub de rueda se asegura el montaje rápido y sencillo en los cubos de rueda de los vehículos.

Advantages \ Ventajas

Reduction of the number of components, implies reduction in assembly time.

Reduction of the space allocated to the bearings, hence weight reduction.

Easy to assemble, since they are already pre-set by the manufacturer.

Minimum maintenance, as it is already lubricated for life.

Low contamination risk, due to minimal handling.

Shorter axle length, hence less distortion and less misalignment.

Reducción del número de componentes, lo cual implica un ahorro de tiempo en el montaje.

Disminución del espacio requerido para el rodamiento, y como consecuencia, del peso.

Sencillez del montaje, dado que el reglaje está ya fijado desde fábrica.

Mínimo mantenimiento, al estar engrasado de por vida.

Menor riesgo de contaminación, al reducir las manipulaciones.

Acortamiento de la longitud del eje, lo que disminuye la deformación y el desalineamiento



F 15097

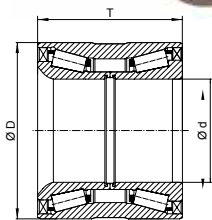

CROSS REFERENCES \ REFERENCIAS CRUZADAS

FAG	201037 \ 571762.H195
SKF	BTH 0018A \ VKBA 5314
TIMKEN	SET 1231 \ NP 078914

OEM REFERENCES \ REFERENCIAS OEM

1413785 \ 1439070 \ 1443078 \ 1476945 \ 1724482 \ 1868087

POSITION \ POSICIÓN

Front axle \ Eje delantero

d (mm.)	D (mm.)	T (mm.)	Weight \ Peso (Kg.)
68/68,2	127/132	115	6,50

BRAND / MARCA

SCANIA



93 \ 113 \ 143 \ K3 \
K4 \ SERIE 3 \ SERIE 4



SERIE 3

F 15100

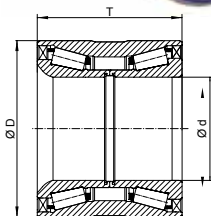

CROSS REFERENCES \ REFERENCIAS CRUZADAS

FAG	805003A.H195
SKF	BTH 0022 \ BTH 0055 \ VKBA 5412

OEM REFERENCES \ REFERENCIAS OEM

014 981 51 05 \ 014 981 93 05 \ 014 981 99 05 \ 017 981 50 05

POSITION \ POSICIÓN

Trailer Axle \ Eje de tráiler

d (mm.)	D (mm.)	T (mm.)	Weight \ Peso (Kg.)
82	140	115	6,45

BRAND / MARCA

GIGANT

MERCEDES
BENZ

SCHMITZ
CARGOBUL



D - SERIE \
G - SERIE

TE \ TL \ TZ

SPR \ SCS \
SKO

F 15120

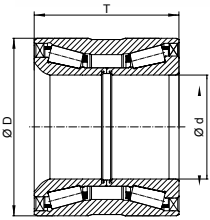
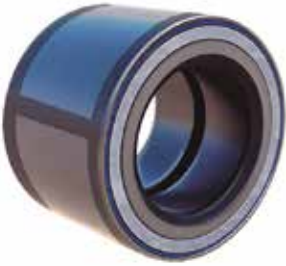

CROSS REFERENCES \ REFERENCIAS CRUZADAS

FAG	201050
KOYO	DU60108-8

OEM REFERENCES \ REFERENCIAS OEM

015 981 19 05

POSITION \ POSICIÓN

Front axle \ Eje delantero

d (mm.)	D (mm.)	T (mm.)	Weight \ Peso (Kg.)
60	108	75	2,83

BRAND / MARCA

MERCEDES BENZ



ACTROS MP2 \
ATEGO 2 \ AXOR 2

F 15121

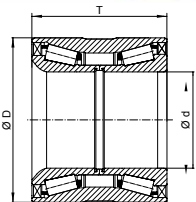

CROSS REFERENCES \ REFERENCIAS CRUZADAS

FAG	713 6908 40
SKF	BTH 1011 \ VKBA 3552

OEM REFERENCES \ REFERENCIAS OEM

7180066

POSITION \ POSICIÓN

Rear axle \ Eje trasero

d (mm.)	D (mm.)	T (mm.)	Weight \ Peso (Kg.)
55	90	60	1,40

BRAND / MARCA

IVECO



DAILY I

F 15122

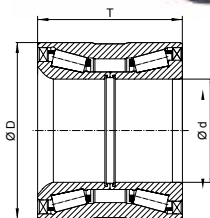

CROSS REFERENCES \ REFERENCIAS CRUZADAS

FAG	201059 / 805012.06.H195
SKF	BTH 0053 / VKBA 5397
TIMKEN	NP 318274-90UA7 / SET 1242

OEM REFERENCES \ REFERENCIAS OEM

1905487 / 2996882 / 7179751 / 7183074 / 7183075 / 7189050 / 7189648

POSITION \ POSICIÓN

Rear axle / Eje trasero

d (mm.)	D (mm.)	T (mm.)	Weight \ Peso (Kg.)
90	160	125	10,20

BRAND / MARCA	IVECO	IRISBUS
	EUROSTAR \ EUROTECH \ STRALIS	
		EURORIDER

F 15125

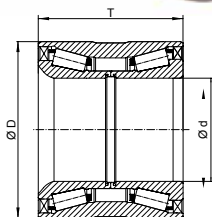

CROSS REFERENCES \ REFERENCIAS CRUZADAS

FAG	803194 A
-----	----------

OEM REFERENCES \ REFERENCIAS OEM

013 981 22 05 / 013 981 23 05 / 013 981 98 05

POSITION \ POSICIÓN

Rear axle / Eje trasero

d (mm.)	D (mm.)	T (mm.)	Weight \ Peso (Kg.)
78	130	90	4,36

BRAND / MARCA	MERCEDES BENZ
	ATEGO \ ATEGO 2 \ TOURINO

F 15126

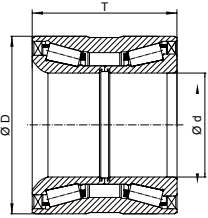

CROSS REFERENCES \ REFERENCIAS CRUZADAS

FAG	805011 C
SKF	VKBA 5409
TIMKEN	SET 1237

OEM REFERENCES \ REFERENCIAS OEM

2994058 / 7184079 / 7184080

POSITION \ POSICIÓN

Rear axle / Eje trasero

d (mm.)	D (mm.)	T (mm.)	Weight \ Peso (Kg.)
82	140	110	6,60

BRAND / MARCA

IVECO

MERITOR



EURO CARGO



TC

F 15127

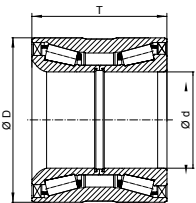

CROSS REFERENCES \ REFERENCIAS CRUZADAS

FAG	805092 C
-----	----------

OEM REFERENCES \ REFERENCIAS OEM

7182915 / 81.93420-0336 / 81.93420-0379 / 81.93420-6083 /
 81.93420-6099 / 8510 3257

POSITION \ POSICIÓN

Rear axle \ Eje trasero

d (mm.)	D (mm.)	T (mm.)	Weight \ Peso (Kg.)
77	130	91	4,35

BRAND / MARCA

IVECO

MAN

VOLVO



EURO POLIS
 ELECTRIC



EURO CARGO

TGL \ TGM
 L 2000

FL6

F 15300

New Reference /
Nueva Referencia

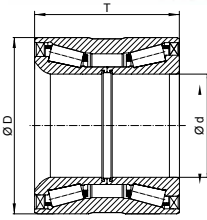

CROSS REFERENCES \ REFERENCIAS CRUZADAS

FAG 805003CA.H195

OEM REFERENCES \ REFERENCIAS OEM

81 93420 0344 * 81 93420 0354

POSITION \ POSICIÓN

Rear axle / Eje trasero

d (mm.)	D (mm.)	T (mm.)	Weight \ Peso (Kg.)
82	140	110	6,60

BRAND / MARCA

MAN



TGL \ TGM



A series of horizontal dotted lines for writing, spanning the width of the page.

21

WHEEL END KIT

KIT DE RUEDA

Introduction \ Introducción

The Fersa Wheel end kit is a high-precision pre-set unit, meant to optimize performance when used in all kinds of commercial vehicles.

The high quality grease used in the pre-greased KWT units' guarantees outstanding performance in the most extreme conditions.

Los rodamientos Fersa "Kit de rueda" son conjuntos de rodamientos de alta precisión, preajustados, cuyo funcionamiento es óptimo para todo tipo de aplicaciones en vehículo industrial.

Los Kit de rueda son unidades previamente engrasadas con grasa de alta calidad que garantizan su uso en las condiciones más exigentes.

Advantages \ Ventajas

Life lubricated compact units.

Same OEM bearing quality, manufactured with the best materials:

- Special steels that guarantee bearing resistance.
- Viton (FKM) Seals for high temperature performance.
- High performance EP2 grease.
- Optimized geometries and optimized profiles.

Each unit incorporates its own assembly tool patented by Fersa, that functions as a fitting tool of units and, when inverted, hub seals.

The patented design by Fersa get a correct fitting of bearing units and seals. Also it protects raceways from damage during transportation and assembly.

Each unit is identified as INBOARD or OUTBOARD for immediate identification of its assembly position in the hub and each VCI package contains the corresponding seal.

Unidades compactadas lubricadas de por vida.

Misma calidad que el rodamiento OEM, fabricado con los mejores materiales:

- Aceros especiales que garantizan la durabilidad del rodamiento.
- Retenes de vitón (FKM) para funcionar a altas temperaturas.
- Grasa de altas prestaciones EP2.
- Geometrías y perfiles optimizados.

Cada unidad de los kit de rueda incorpora su propia herramienta de montaje patentada por Fersa, que sirve como herramienta para el calado de las unidades, y en posición invertida, para el calado del retén en el buje.

Este diseño patentado por Fersa permite que las unidades y retenes sean montadas correctamente y con la presión adecuada. Además de proteger de golpes y marcas las pistas de ro-dadura durante el transporte y montaje.

Cada una de las unidades viene identificada como INBOARD y OUTBOARD para el fácil reconocimiento de su posición de montaje en el buje y acompañadas en la misma bolsa de su retén correspondiente.

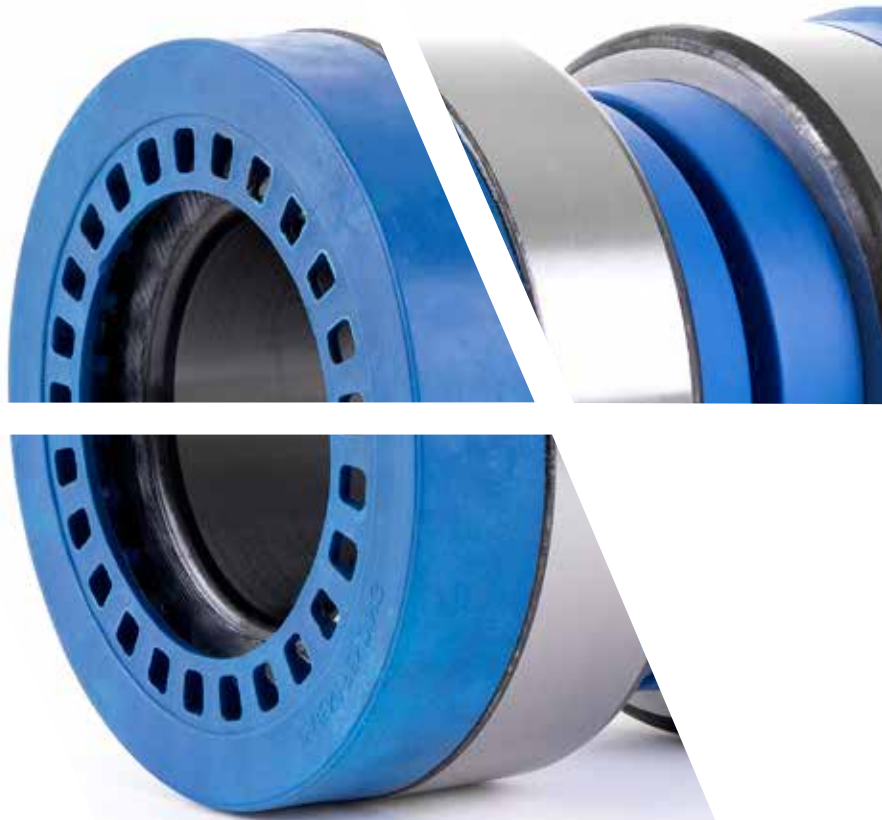

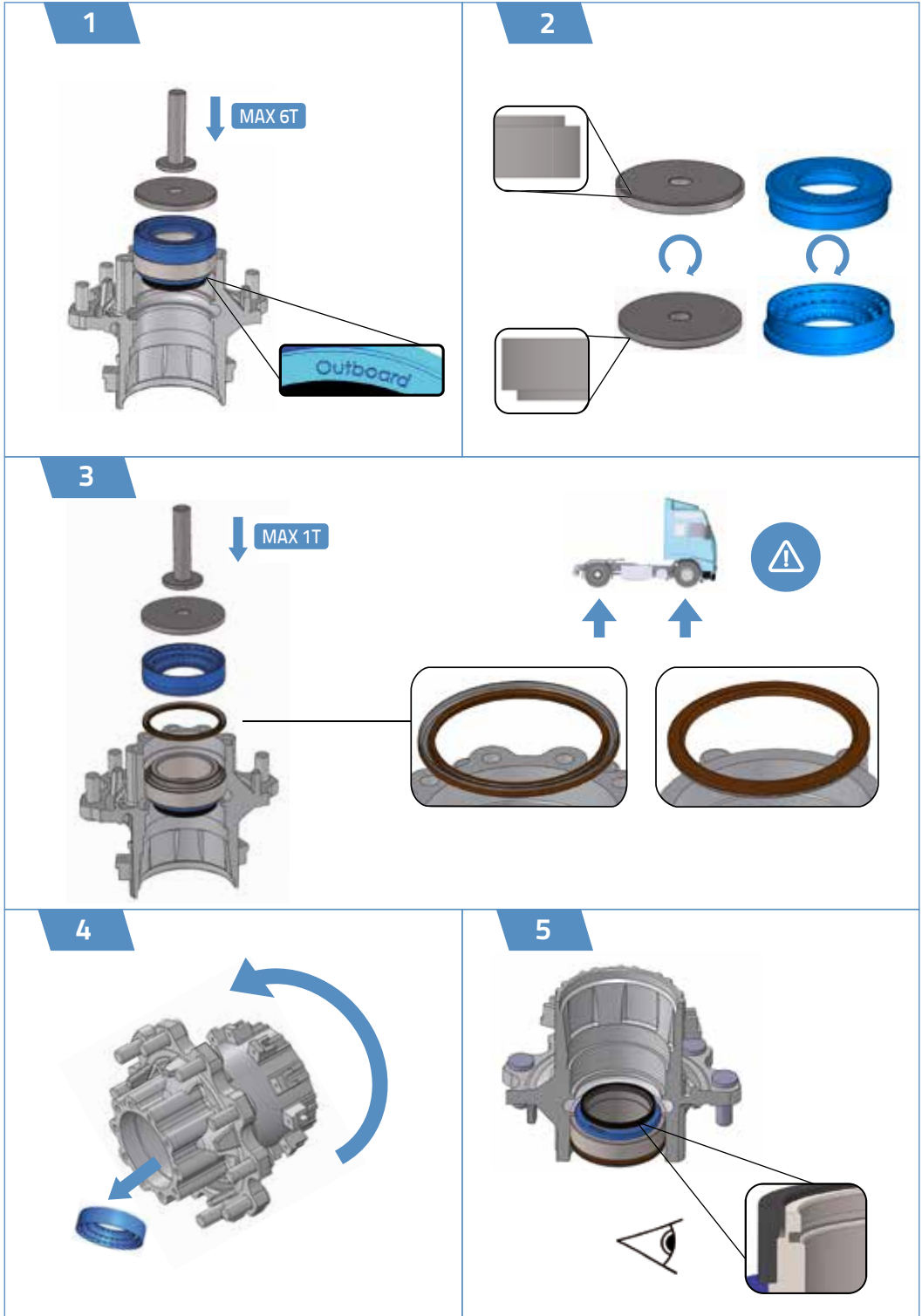

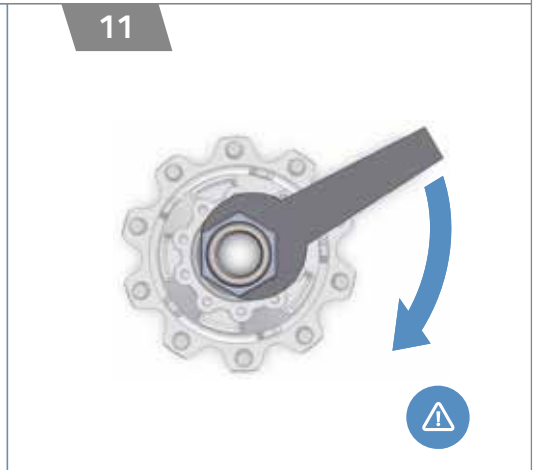
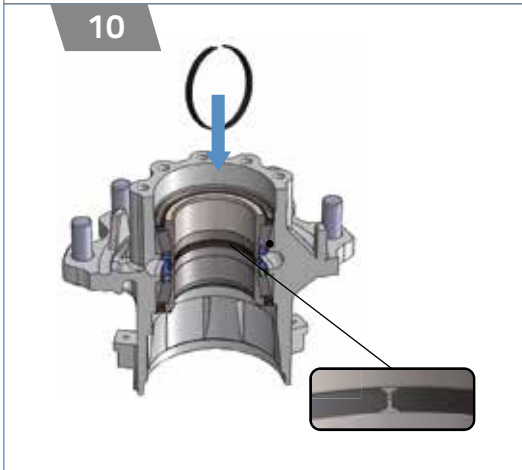
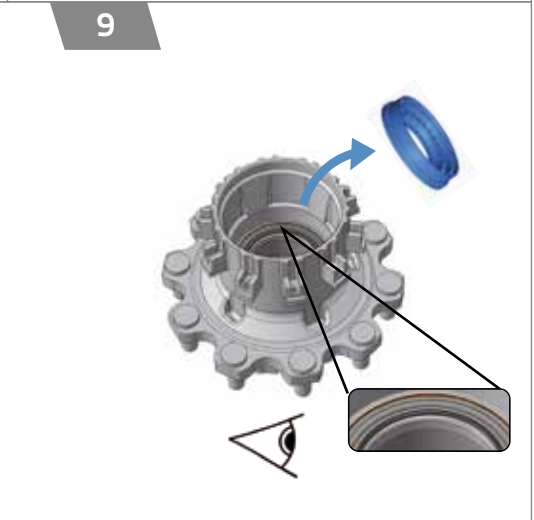
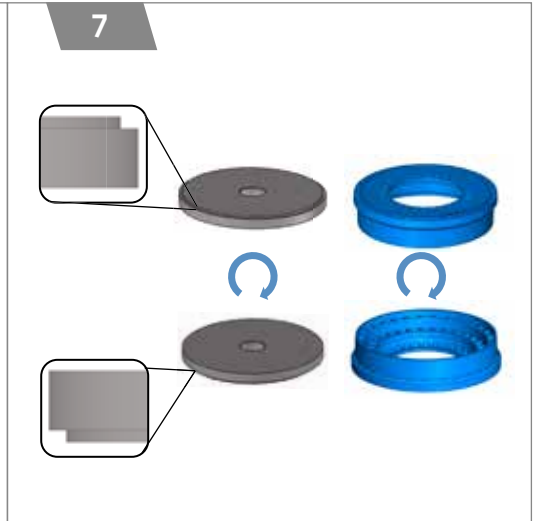
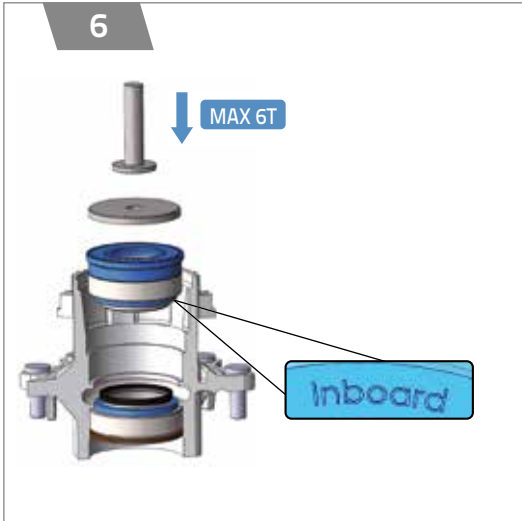

F 200004

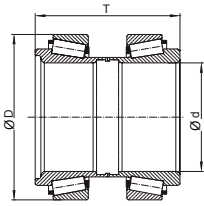

CROSS REFERENCES \ REFERENCIAS CRUZADAS

FAG 803750 B



OEM REFERENCES \ REFERENCIAS OEM

36934200009 / 5031 26457 / 81.93420-0320 / 81.93420-0342

POSITION \ POSICIÓN

Rear axle / Eje trasero

d (mm.)	D (mm.)	T (mm.)	Weight \ Peso (Kg.)
105	160	140	6,86

BRAND / MARCA	BOVA	MAN	MERCEDES BENZ	NEOPLAN	VOLVO
		TGA, TGM TGS, TGX M 2000			
	FUTURA LEXIO MAGIG SINERGY	LIONS COACH LIONS CITY HOCL, NG, NL, NU, SL, UL	CITARO	CITYLINER EUROLINER STARLINER	7700 8500 8700

F 200005

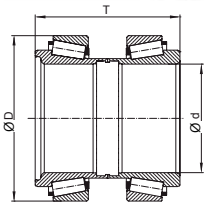

CROSS REFERENCES \ REFERENCIAS CRUZADAS

FAG 804162 A

SKF VKBA 5416

OEM REFERENCES \ REFERENCIAS OEM

81.93420-0346

POSITION \ POSICIÓN

Rear axle / Eje trasero

d (mm.)	D (mm.)	T (mm.)	Weight \ Peso (Kg.)
110	170	146	8,53

BRAND / MARCA	MAN
	TGA, TGM TGS

F 200013

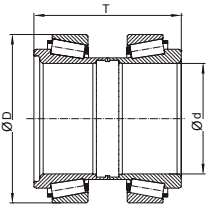

Fersa Bearings's patented product /
 Producto patentado por Fersa Bearings

CROSS REFERENCES \ REFERENCIAS CRUZADAS

FAG	566426.H195
SKF	VKBA 5425
TIMKEN	SET 1312



OEM REFERENCES \ REFERENCIAS OEM

20382168 / 20518092 / 20518093 / 20518637 / 20558950 / 20581399
 / 20728008 / 20967831 / 21021391 / 2051 8637 /
 2096 7831 / 2102 1391 / 3988673 / 3988674 / 3988675 /
 74 20 967 831 / 74 20 518 637 / 74 21 021 391

POSITION \ POSICIÓN

Front axle / Eje delantero

d (mm.)	D (mm.)	T (mm.)	Weight \ Peso (Kg.)
68/68,2	125	115	4,45

BRAND / MARCA	RENAULT	VOLVO
	Magnum Premium 2 Kerax	TGA, TGM TGS, TGX M 2000
		B6, 7700, 8500, 8700, 9700, 9900

F 200014

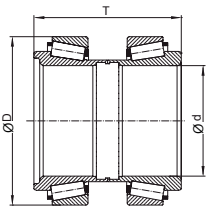

Fersa Bearings's patented product /
 Producto patentado por Fersa Bearings

CROSS REFERENCES \ REFERENCIAS CRUZADAS

FAG	566425.H195
SKF	VKBA 5423
TIMKEN	SET 1314



OEM REFERENCES \ REFERENCIAS OEM

1075 408 / 20517952 / 20518661 / 20535231 / 20558966 / 20967828
 / 21036050 / 2079 2439 / 2079 2440 / 2079 2440 / 3988 774 / 74 20
 792 439

POSITION \ POSICIÓN

Rear axle / Eje trasero

d (mm.)	D (mm.)	T (mm.)	Weight \ Peso (Kg.)
93,8/94	148	135	5,40

BRAND / MARCA	RENAULT	VOLVO
	Magnum Premium 2 Kerax	XF, Magnum, Premium 2, Kerax FE, FH, FH 12, FH 16, FL 6, FL 7, FL 10, FL 12, FM, FM 7, FM 9, FM 12, NH 12
		B6, 7700, 8500, 8700, 9700, 9900

F 200015

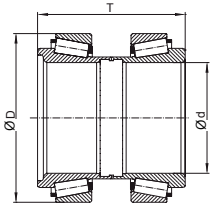

Fersa Bearings's patented product /
Producto patentado por Fersa Bearings

F 200016

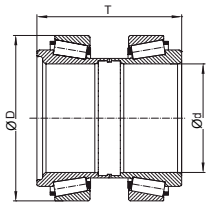

Fersa Bearings's patented product /
Producto patentado por Fersa Bearings

CROSS REFERENCES \ REFERENCIAS CRUZADAS

FAG	566427.H195 / 805165
TIMKEN	SET1311
SKF	VKBA 5424



OEM REFERENCES \ REFERENCIAS OEM

20518617 / 20967830 / 20589393 / 20589394 / 21021381

POSITION \ POSICIÓN

Front axle / Eje delantero

d (mm.)	D (mm.)	T (mm.)	Weight \ Peso (Kg.)
58,0/ 57,8	110	115	3,64

BRAND / MARCA	RENAULT	VOLVO
	Magnum Premium 2	FM 9, FH 12 FM 12, FH 16 FE, FH, FM
		B6, 7700, 8500, 8700, 9700, 9900

CROSS REFERENCES \ REFERENCIAS CRUZADAS

FAG	566074.H195
-----	-------------

OEM REFERENCES \ REFERENCIAS OEM

1801592

POSITION \ POSICIÓN

Front axle / Eje delantero

d (mm.)	D (mm.)	T (mm.)	Weight \ Peso (Kg.)
70 / 69,8	131,5 / 125	114	4,86

BRAND / MARCA	DAF
	65CF, 75CF, 85CF, CF65 CF65II, CF65IV, CF75, CF75II, CF75IV CF85, CF85II, CF85IV, LF55, LF55IV XF95, XF95II, XF105



F 200017

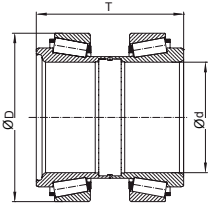

Fersa Bearings's patented product /
 Producto patentado por Fersa Bearings

CROSS REFERENCES \ REFERENCIAS CRUZADAS

FAG 566283.H195

OEM REFERENCES \ REFERENCIAS OEM

1801594

POSITION \ POSICIÓN

Rear axle / Eje trasero

d (mm.)	D (mm.)	T (mm.)	Weight \ Peso (Kg.)
99,80/100,00	148,0	135,0	6,003

BRAND / MARCA



DAF

65CF, 75CF, 85CF, CF65
 CF65II, CF65IV, CF75, CF75II, CF75IV
 CF85, CF85II, CF85IV, LF55, LF55IV
 XF95, XF95II, XF105

F 200018

New Reference /
 Nueva Referencia

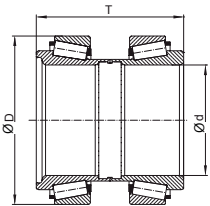
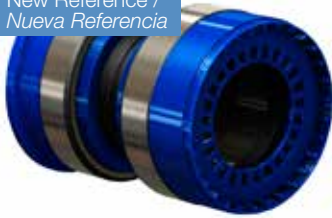

Fersa Bearings's patented product /
 Producto patentado por Fersa Bearings

CROSS REFERENCES \ REFERENCIAS CRUZADAS

FAG 566193.H195

OEM REFERENCES \ REFERENCIAS OEM

1801593

POSITION \ POSICIÓN

Front axle / Eje delantero

d (mm.)	D (mm.)	T (mm.)	Weight \ Peso (Kg.)
82,0	138,0	130,0	6,1

BRAND / MARCA



DAF

CF 75, 85 CF,
 CF 85, XF 95,
 XF 105



.....

.....

.....

F 200019

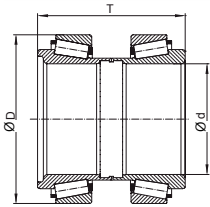

Fersa Bearings's patented product /
Producto patentado por Fersa Bearings

F 200025

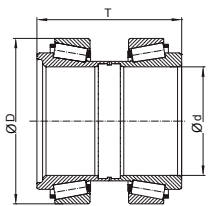

Fersa Bearings's patented product /
Producto patentado por Fersa Bearings

CROSS REFERENCES \ REFERENCIAS CRUZADAS

FAG 566834.H195

OEM REFERENCES \ REFERENCIAS OEM

1801595

POSITION \ POSICIÓN

Front axle / Eje delantero

d (mm.)	D (mm.)	T (mm.)	Weight \ Peso (Kg.)
69,800/ 70,00	119,700/ 124,7	110,500	4,50

BRAND / MARCA

DAF



65CF, 75CF, 85CF, CF65
CF65II, CF65IV, CF75, CF75II, CF75IV
CF85, CF85II, CF85IV, LF55, LF55IV
XF95, XF95II, XF105

CROSS REFERENCES \ REFERENCIAS CRUZADAS

FAG 570530.H195

OEM REFERENCES \ REFERENCIAS OEM

03 200 1020 00 * 03 434 3020 00

POSITION \ POSICIÓN

Trailer axle / Eje de Tráiler

d (mm.)	D (mm.)	T (mm.)	Weight \ Peso (Kg.)
88,0	138,0	120,0	5,1

BRAND / MARCA

SAF



B9-19K * B9-19W *
B9-22K01 * B9-22W
BA9-22K01
BI9-19K * BI9-19W *
BI9-22K01 * BI9-22W *
BI9-22W-6 * BINL9-22K01
S7-3015
S9-3718 * S9-4220
S11-3720 * S11-4218 *
S11-4220
S11-19 * S11-22 * S19-19 * S19-22 * SIL11-22 *
SL11-4220 * SZL11-4220 * SL9-3718 * SL9-4218 *
SZL11-4218
Z

F 200028

New Reference /
Nueva Referencia

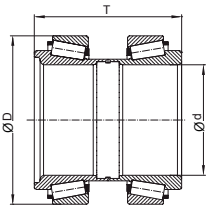

Fersa Bearings's patented product /
Producto patentado por Fersa Bearings

F 200029

New Reference /
Nueva Referencia

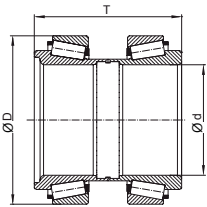

Fersa Bearings's patented product /
Producto patentado por Fersa Bearings

CROSS REFERENCES \ REFERENCIAS CRUZADAS

F AG 566830.H195

OEM REFERENCES \ REFERENCIAS OEM

03 434 3010 00 * 03 434 3012 00 * 04 200 1016 01 * 04 200 1016 02

POSITION \ POSICIÓN

Trailer axle / Eje de tráiler

d (mm.)	D (mm.)	T (mm.)	Weight \ Peso (Kg.)
120,0	175,0	123,0	-

BRAND / MARCA	SAF
	SK, SKRS, SKRZ

CROSS REFERENCES \ REFERENCIAS CRUZADAS

FAG 569868.H195

OEM REFERENCES \ REFERENCIAS OEM

03 434 3018 00 * 04 200 1019 00

POSITION \ POSICIÓN

Trailer axle / Eje de tráiler

d (mm.)	D (mm.)	T (mm.)	Weight \ Peso (Kg.)
82,0	138,0	110,0	5,8

BRAND / MARCA	SAF
	SKRB SKRLB



.....

.....

.....

F 200031

New Reference /
 Nueva Referencia

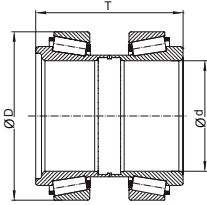

Fersa Bearings's patented product /
 Producto patentado por Fersa Bearings



Series of horizontal dotted lines for handwritten notes.

CROSS REFERENCES \ REFERENCIAS CRUZADAS

FAG 566847.H195

OEM REFERENCES \ REFERENCIAS OEM

03 434 3011 00

POSITION \ POSICIÓN

Trailer axle / Eje de tráiler

d (mm.)	D (mm.)	T (mm.)	Weight \ Peso (Kg.)
100,0	1485,0	141,0	5,45

BRAND / MARCA	SAF
	SKRLS* SKRLZ



A series of horizontal dotted lines for writing, spanning the width of the page.

3 \

WHEEL END MODULE

MODULO DE RUEDA

Introduction \ Introducción

The Fersa Wheel end module are bearings integrated in the wheel hub.

Wheel end module are units made up of two perfectly aligned, lubricated for life and pre-set bearings, meeting the market's most demanding requirements. They are lubricated with the highest quality grease in order to enhance their performance under the most adverse conditions. Like the previous bearing units, their assembly is simple and practical.

Los rodamientos Fersa "Modulo de rueda" son rodamientos compactos e integrados en el cubo de la rueda del vehículo.

Nuestros Modulos de rueda, son unidades formadas por dos rodamientos perfectamente alineados, lubricados de por vida y preajustados para cumplir las más altas exigencias del mercado. Usamos grasa de alta calidad para asegurar su funcionamiento con las condiciones más adversas. Asegurando así mismo un montaje en la aplicación simple y práctico.

Advantages \ Ventajas

Simple assembly, direct replacement of the defective unit.

Reduction of the space allocated to the bearings, hence weight reduction.

Easy to adjust, since they are already pre-set by the manufacturer.

Minimum maintenance, as it is already lubricated for life by the manufacturer.

Low contamination risk, due to minimal handling.

Shorter axle length, hence less distortion and less misalignment.

Montaje sencillo, sustitución de un conjunto por otro.

Reducción del espacio requerido para el rodamiento, y como consecuencia, del peso.

Sencillez de ajuste, dado que el reglaje está ya fijado desde fábrica.

Mínimo mantenimiento, al venir engrasado de por vida.

Menor riesgo de contaminación, al reducir las manipulaciones.

Acortamiento de la longitud del eje, lo que disminuye la deformación y el desalineamiento.



F 300001

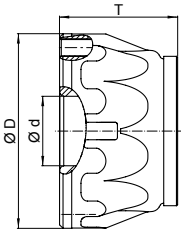

CROSS REFERENCES \ REFERENCIAS CRUZADAS

FAG 564734.H195

OEM REFERENCES \ REFERENCIAS OEM

1002689 / 1003457 / 100167600 / 100167601 / 3 200 2001 51 /
 3 434 3650 00 / 4 200 2001 00 / 4 200 2001 01

POSITION \ POSICIÓN

Trailer axle / Eje Tráiler

d (mm.)	D (mm.)	T (mm.)	Weight \ Peso (Kg.)
82	196	110	15,30

Sold with 12 bolts / Incluye 12 tornillos

BRAND / MARCA	sAF	SCHMITZ CARGOBÜL
	9019-1122	SKI SPR SCS SKO

F 300003

New Reference /
 Nueva Referencia

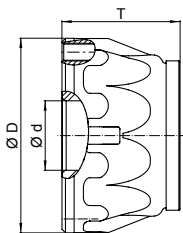

CROSS REFERENCES \ REFERENCIAS CRUZADAS

SNR HDS001 * HUR 040

OEM REFERENCES \ REFERENCIAS OEM

RVI 50 10 439 770
 VOLVO 20764313

POSITION \ POSICIÓN

Front axle / Eje delantero

d (mm.)	D (mm.)	T (mm.)	Weight \ Peso (Kg.)
70,0	195,0	110,0	11,22

BRAND / MARCA	RENAULT TRUCKS
	Kerax Magnum Midlum Premium (Front and Rear axle / Eje delantero y trasero)



F 300005

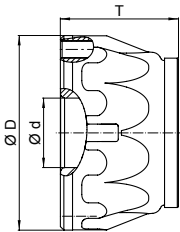

CROSS REFERENCES \ REFERENCIAS CRUZADAS

FAG	801974AE.H195
SKF	BTF 0110 / VKBA 5377



OEM REFERENCES \ REFERENCIAS OEM

42541578 / 5006207845 / 81.93420-0288 / 81.93420-0330 / 81.93420-0349

POSITION \ POSICIÓN

Front axle / Eje delantero

d (mm.)	D (mm.)	T (mm.)	Weight \ Peso (Kg.)
70	196	140	13,20

BRAND / MARCA	IVECO	MAN
	CITYCLASS EUROPOLIS	HOCL, LIONS COACH, LIONS CITY LIONS STAR, NG, NL, NM, NÜ, RH SG, SL, SÚ, TOURLINER, ÚL, UN
	9019-1122	TGA, TGM, TGS, TGX E 2000, F 2000, M 2000

F 300006

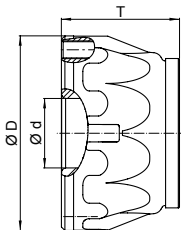

CROSS REFERENCES \ REFERENCIAS CRUZADAS

FAG	713 6908 50
SKF	VKBA 3553 / BTFB 328755 D

OEM REFERENCES \ REFERENCIAS OEM

9381 0034

POSITION \ POSICIÓN

Front axle / Eje delantero

d (mm.)	D (mm.)	T (mm.)	Weight \ Peso (Kg.)
45	120	85	4,00

BRAND / MARCA	IVECO
	DAILY



.....

.....

.....

.....

F 300007

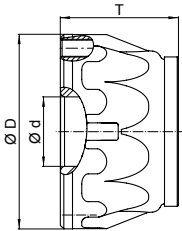

CROSS REFERENCES \ REFERENCIAS CRUZADAS

FAG	805532
DT	6.54106

OEM REFERENCES \ REFERENCIAS OEM

20550678 / 5010587029

POSITION \ POSICIÓN

Front axle / Eje delantero

d (mm.)	D (mm.)	T (mm.)	Weight \ Peso (Kg.)
60	168	100	9,30

BRAND / MARCA

RENAULT



MIDLUM

F 300010

New Reference /
Nueva Referencia

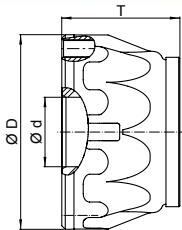

CROSS REFERENCES \ REFERENCIAS CRUZADAS

FAG	05532.01.H19
-----	--------------

OEM REFERENCES \ REFERENCIAS OEM

20550678 / 5010587029 / SL279/1

POSITION \ POSICIÓN

Front axle / Eje delantero

d (mm.)	D (mm.)	T (mm.)	Weight \ Peso (Kg.)
60	168	100	9,4

BRAND / MARCA

ALEXANDER
DENNIS

VDL

DANA



ENVIRO 200

AMBASSADOR
ALE 120-
105/225 *
Citea LLE-120

NDS 56





A series of horizontal dotted lines for writing, starting from the top of the page and extending to the bottom.

4 \

PRESET HUB ASSEMBLY

RODAMIENTO INTEGRAL DE RUEDA

Introduction \ Introducción

Our Preset hub assembly bearings are composed of two mechanical components, bearing - housing, when coupled, they allow handling of the piece at the time of assembly or disassembly. In addition, the combination of all of the elements in a single set guarantees excellent fit and improvements in working conditions.

Preset hub assemblies are the ideal solution that provides a fast, safe, and efficient assembly, guaranteeing a longer service life for the bearing.

Los rodamientos integrales están compuestos por dos componentes mecánicos, rodamiento -soporte, que acoplados facilitan la manipulación de la pieza a la hora de su montaje o desmontaje. Además, la combinación de todos los elementos en un único conjunto garantiza un excelente ajuste y mejoras en las condiciones de trabajo.

Los rodamientos integrales son la solución idónea que proporciona un montaje rápido, seguro y eficaz, garantizando una mayor vida útil del rodamiento.

Advantages \ Ventajas

Integration solutions for our bearings are manufactured and assembled for easier mounting, ensuring optimal performance of your components.

Security and comfort \ minimum amount of necessary handling.

Speed \ ease of mounting, thanks to it being one unified piece.

Efficiency \ excellence in the development, design, manufacture and mounting of the piece.

Las soluciones de integración de nuestros rodamientos están fabricadas y ensambladas para facilitar el montaje, asegurando el funcionamiento óptimo de sus componentes.

Seguridad y Comodidad \ mínimo número de manipulaciones necesarias.

Rapidez \ facilidad de montaje, gracias a ser una única pieza.

Eficacia \ excelencia en el desarrollo, diseño, fabricación y montaje de la pieza.



4 \ Preset hub assembly Rodamiento integral de rueda



F 400001



BRAND / MARCA	OEM	POSITION \ POSICIÓN	REMARK
MERCEDES BENZ	000 350 2335	Trailer axle / Eje Tráiler	Brake disc screws included / Tornillos de disco de freno incluidos



F 400002



BRAND / MARCA	OEM	POSITION \ POSICIÓN	REMARK
DAF	1691621 * 1699327 * 1818004	Fron axle / Eje delantero	Brake disc / Disco de freno



F 400003



BRAND / MARCA	OEM	POSITION \ POSICIÓN	REMARK
DAF	1657637 * 1812161 * 2019802	Rear axle / Eje trasero	Brake disc / Disco de freno



F 400004



BRAND / MARCA	OEM	POSITION \ POSICIÓN	REMARK
DAF	1389061 * 1391617 * 1391517 * 1818003	Rear axle / Eje trasero	Brake disc / Disco de freno



F 400005



BRAND / MARCA	OEM	POSITION \ POSICIÓN	REMARK
SAF	3307304500	Trailer axle / Eje Tráiler	Brake disc / Disco de freno* Eje BI-9



F 400006



BRAND / MARCA	OEM	POSITION \ POSICIÓN	REMARK
VOLVO * RENAULT TRUCK	20820420 * 20819822 * 20499882 * 7420819859 * 7420820420	Rear axle / Eje trasero	Brake drum / Freno de tambor



F 400007



BRAND / MARCA	OEM	POSITION \ POSICIÓN	REMARK
VOLVO * RENAULT TRUCK	85105696 * 3988833	Rear axle / Eje trasero	Brake disc * 27 mm bolts / Disco de freno * pernos 27 mm



F 400008



BRAND / MARCA	OEM	POSITION \ POSICIÓN	REMARK
VOLVO * RENAULT TRUCK	85107753 * 20535263	Rear axle / Eje trasero	Brake disc * 25 mm bolts / Disco de freno * pernos 25 mm



F 400009



BRAND / MARCA	OEM	POSITION \ POSICIÓN	REMARK
VOLVO * RENAULT TRUCK	85114470 * 85111791 * 85111448 * 20535202	Front axle / Eje delantero	Brake disc / Disco de freno



F 4000010



BRAND / MARCA	OEM	POSITION \ POSICIÓN	REMARK
VOLVO * RENAULT TRUCK	85111789 * 85107749	Front axle / Eje delantero	Brake disc / Disco de freno



F 4000012



BRAND / MARCA	OEM	POSITION \ POSICIÓN	REMARK
SAF	3307303001	Trailer axle / Eje Tráiler	Brake disc * SKRB axle / Disco de freno * eje SKRB



.....

.....

.....

.....



5\

COMPLEMENTS

COMPLEMENTOS



5.1 Grease /
Grasa



MULTIPURPOSE GREASE / GRASA DE USO GENERAL

Multipurpose uses grease designed to withstand demanding mechanical conditions and large lubrication frequencies

Grasa multiusos diseñada para resistir condiciones mecánicas exigentes y grandes frecuencias de lubricación

Composition / Composición

Nature of the thickener	Naturaleza del Espesante	Lithium Soap / Jabón de litio
Drop Point (°C)	Punto de Gota (°C)	>185
Oil Viscosity (cSt at 40°C)	Viscosidad del aceite (cST a 40°C)	150
Welding Load (4 balls)	Carga de Soldadura (4 bolas)	>2500 N
Color	Color	Light brown / Ambar
Service temperature	Temperatura de uso	-20 a 120 °C (4 a 248 °F)



SPECIAL WHEEL END GREASE / GRASA ESPECIAL DE RUEDA

Special grease for commercial vehicles for wheel ends, designed to reduce lubrication periods up to 80% compared to conventional lithium grease

Grasa especial para rueda de vehículo industrial diseñada para reducir los periodos de lubricación hasta un 80% respecto a las grasas líticas convencionales

Composition / Composición

Nature of the thickener	Naturaleza del Espesante	Litio Complex / Litio complejo
Drop Point (°C)	Punto de Gota (°C)	>250
Oil Viscosity (cSt at 40°C)	Viscosidad del aceite (cST a 40°C)	150
Welding Load (4 balls)	Carga de Soldadura (4bolas)	>3150 N
Color	Color	Blue / Azul
Service temperature	Temperatura de uso	-20 a 160 °C. (4 a 320 °F)



A series of horizontal dotted lines for writing, spanning the width of the page.

5.2 Fersa tools /
Herramientas Fersa

PRESS TOOL KITS / KIT DE HERRAMIENTAS PARA PRENSA



BTA 001

BRAND / MARCA

REF. FERSA

VOLVO

F 200013 / F 200014 / F 200015



BTA 003

BRAND / MARCA

REF. FERSA

BPW

32310 F / 33116 F



BTA 005

BRAND / MARCA

REF. FERSA

DAF

F 200016 / F 200017 / F 200018 / F 200019



BTA 006

BRAND / MARCA

REF. FERSA

MULTI-BRAND /
MULTIMARCA

for complete disassembly with press /
para el desmontaje de rodamientos con prensa



BTA 007

BRAND / MARCA

REF. FERSA

SCANIA

F 15097 / HM 218248/10

MANUAL TOOL KIT / KIT DE HERRAMIENTA MANUAL

BTA 002



BRAND / MARCA

REF. FERSA

VOLVO

F 200013 / F 200014 / F 200015

BTA 004

BRAND / MARCA

REF. FERSA

BPW

32222 F / 32314 F / 33215 F / 32219 F / 33213 F /
33118 F



Lined writing area consisting of multiple horizontal dotted lines for notes.

6\

CROSS REFERENCES

CRUCE DE REFERENCIAS

6.1 Competitor Cross References /

Cruce de Referencias con la competencia

FAG	Fersa
201034	F 15100
201037	F 15097
201043	F 300003
201050	F 15120
201059	F 15122
564734.H195	F 300001
566074.H195	F 200016
566193.H195	F 200018
566283.H195	F 200017
566425.H195	F 200014
566426.H195	F 200013
566427.H195	F 200015
566830.H195	F 200028
566847.H195	F 200031
569868.H195	F 200029
570530.H195	F 200025
571762.H195	F 15097
581079 C	F 200013
713690850	F 300006
800792 D	F 200014
801974AE.H195	F 300005
803194 A	F 15125
803750 B	F 200004
804162 A	F 200005
805003A.H195	F 15100
805003CA.H195	F 15300

805011 C	F 15126
805012.06.H195	F 15122
805092 C	F 15127
805532	F 300007
805532.01.H195	F 300010

KOYO	Fersa
DU60108 B	F 15120

SKF	Fersa
BTF 0021 A	F 300005
BTF 0110	F 300005
BTH 0018 A	F 15097
BTH 0022	F 15100
BTH 0053	F 15122
BTH 0055	F 15100
BTH 1011	F 15121
VKBA 3552	F 15121
VKBA 3553	F 300006
VKBA 5314	F 15097
VKBA 5377	F 300005
VKBA 5397	F 15122
VKBA 5409	F 15126
VKBA 5412	F 15100
VKBA 5416	F 200005
VKBA 5423	F 200014
VKBA 5424	F 200015
VKBA 5425	F 200013

SNR	Fersa
HDS001	F 300003
HUR 040	F 300003

TIMKEN	Fersa
NP 078914	F 15097
NP 318274-90UA7	F 15122
SET 1231	F 15097
SET 1237	F 15126
SET 1242	F 15122
SET 1277	F 15126
SET 1311	F 200015
SET 1312	F 2000013
SET 1312	F 200013
SET 1314	F 200014

6.2 OEM Cross References / Cruce de Referencias OEM

OEM	Fersa
DAF	
1389061	F 400004
1391517	F 400004
1391617	F 400004
1400291	F 15122
1408086	F 15122
1657637	F 400003
1691621	F 400002
1699327	F 400002
1735191	F 200014
1801592	F 200016
1801593	F 200018
1801594	F 200017
1812161	F 400003
1818003	F 400004
1818004	F 400002
2019802	F 400003

DANA	
SL279/1	F 300010

GIGANT	
9272681	F 15100
9272778	F 15100

IVECO	
1905487	F 15122
2994058	F 15126
2996882	F 15122
7179749	F 15122
7179751	F 15122
7180066	F 15121
7182915	F 15127
7183074	F 15122
7183075	F 15122
7184079	F 15126
7184080	F 15126

OEM	Fersa
7189050	F 15122
7189648	F 15122
42541578	F 300005
93824580	F 300006
503126457	F 200004
5006207845	F 300005

MAN	
36 93420 0009	F 200004
81 93420 0288	F 300005
81 93420 0320	F 200004
81 93420 0323	F 300005
81 93420 0330	F 300005
81 93420 0336	F 15127
81 93420 0342	F 200004
81 93420 0344	F 15300
81 93420 0346	F 200005
81 93420 0349	F 300005
81 93420 0354	F 15300
81 93420 0376	F 200004
81 93420 0379	F 15127
81 93420 6083	F 15127
81 93420 6097	F 200004
81 93420 6099	F 15127

MERCEDES BENZ	
000 350 0535	F 15100
000 350 0935	F 15100
000 350 2335	F 400001
013 981 2205	F 15125
013 981 2305	F 15125
013 981 9805	F 15125
014 981 5105	F 15100
014 981 9305	F 15100
014 981 9905	F 15100
015 981 1905	F 15120
017 981 5005	F 15100

OEM	Fersa
943 334 1125	F 15100
975 330 0425	F 15125

RENAULT TRUCK	
7420819822	F 400006
7420535263	F 400008
7420820420	F 400006
7485107753	F 400008
50 01 861 915	F 200014
50 10 439 770	F 300003
50 10 587 029	F 300007
74 20 516 957	F 200014
74 20 518 617	F 200015
74 20 518 637	F 200013
74 20 518 661	F 200014
74 20 535 202	F 200013
74 20 535 203	F 200013
74 20 535 262	F 200014
74 20 535 263	F 200014
74 20 535 264	F 200014
74 20 792 439	F 200014
74 20 819 834	F 200014
74 20 819 846	F 200014
74 20 819 859	F 200014
74 20 819 860	F 200014
74 20 967 831	F 200013
74 21 021 381	F 200015
74 21 021 391	F 200013
74 21 022 433	F 200015
74 21 022 434	F 200015
74 21 024 188	F 200015
74 21 024 206	F 200013
74 21 024 208	F 200013
74 21 036 050	F 200014

OEM	Fersa
SAF	
03 200 1020 00	F 200025
03 200 2001 51	F 300001
03 434 3010 00	F 200028
03 434 3011 00	F 200031
03 434 3012 00	F 200028
03 434 3018 00	F 200029
03 434 3020 00	F 200025
03 434 3650 00	F 300001
3307304500	F 400005
3307303001	F 400012
04 200 1016 01	F 200028
04 200 1016 02	F 200028
04 200 1019 00	F 200029
04 200 2001 00	F 300001
04 200 2001 01	F 300001

SCANIA	
1413785	F 15097
1439070	F 15097
1443078	F 15097
1476945	F 15097
1724482	F 15097
1868087	F 15097

SCHMITZ CARGOBULL	
16477	F 15100
1002689	F 300001
100167600	F 300001
100167601	F 300001

OEM	Fersa
VOLVO	
1075408	F 200014
1078053	F 200014
3099161	F 15120
3099162	F 15125
3943982	F 200014
3988673	F 200013
3988674	F 200013
3988675	F 200013
3988774	F 200014
3988830	F 200013
3988833	F 400007
3989896	F 200014
10003570	F 200015
20382168	F 200013
20499882	F 400006
20517163	F 200014
20517164	F 200014
20517950	F 200014
20517952	F 200014
20518054	F 200014
20518091	F 200013
20518092	F 200013
20518093	F 200013
20518617	F 200015
20518637	F 200013
20518661	F 200014
20523899	F 200015
20535202	F 400009
20535230	F 200014
20535231	F 200014
20535263	F 400008
20550678	F 300007
20558950	F 200013
20558966	F 200014
20567114	F 200013
20581397	F 200013
20581398	F 200013
20581399	F 200013
20728008	F 200013
20764313	F 300003

OEM	Fersa
20792439	F 200014
20792440	F 200014
20819822	F 400006
20820402	F 200014
20820420	F 400006
20967828	F 200014
20967830	F 200015
20967831	F 200013
21021391	F 200013
21024155	F 200013
21024157	F 200013
21024166	F 200013
21024168	F 200013
21024220	F 200013
21024237	F 200013
21024239	F 200013
21036050	F 200014
21048400	F 200013
21116584	F 200013
21328181	F 200014
85101818	F 200013
85103257	F 15127
85103258	F 15126
85104299	F 200014
85104301	F 200014
85105692	F 200015
85105693	F 200013
85105696	F 400007
85107749	F 400010
85107750	F 200013
85107753	F 400008
85111448	F 400009
85111789	F 400010
85111791	F 400009
85111792	F 200015
85111794	F 200013
85114470	F 400009
85114471	F 200013



A series of horizontal dotted lines for writing, starting from the top of the page and extending to the bottom.



A series of horizontal dotted lines spanning the width of the page, providing a guide for handwriting practice. The lines are evenly spaced and extend from the left margin to the right margin.



A series of horizontal dotted lines for writing, spanning the width of the page.

EXPERTS IN BEARING SOLUTIONS

EUROPE
Spain \ Zaragoza

Headquarters Tlf: +34 976 333 850
fersa@fersa.com
Regional branch Tlf: +34 876 269 571
fersaiberia@fersa.com

NORTH AMERICA
U.S.A \ Ohio

Tlf: +1 419-279-5331
fersa.usa@fersa.com

ASIA
China \ Jiaxing

Tlf: +86 (0) 573 8271 6335
fersa.cn@fersa.com

SOUTH AMERICA
Brazil \ Sao Paulo

Tlf: +55 11 4318 4222
fersa.brasil@fersa.com

