



The wise choice for **U**ltra **R**eliable **B**earings

URB GROUP

**BEARINGS FOR VARIOUS
GEARBOXES**

**Special
and
Standard
Bearings**



URB GROUP



320 Republicii Street,
731108 Barlad,
ROMANIA



phone: +40 235 / 411120, 412120
fax: +40 235 / 413838, 308200
www.urbgroup.com

INDUSTRY

Bearings for Industrial gears

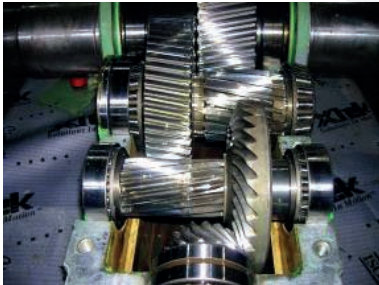

Bearings for Mining gears

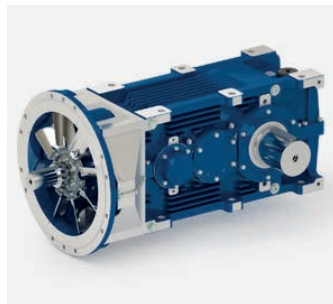

Bearings for Machine tool gears

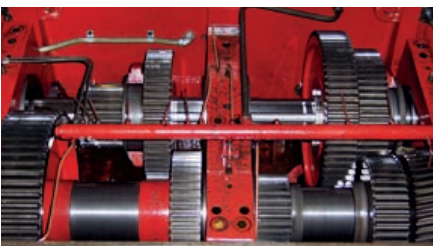

Bearings for Wind turbine gears

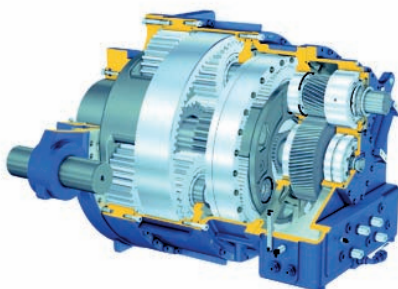

BEARINGS REQUIREMENTS

- *Minimum maintenance*
- *Simple design*
- *High load carrying capacity*
- *Low friction*

Operating in extreme environmental influences (dirt, dust, water, etc.)

- *Low vibration*
- *High rigidity*
- *High capacity, to support heavy impact*







- *High speed*
- *Extreme precision or stiffness*
- *Low friction*
- *High rigidity*

- *Minimum maintenance*
- *Low friction*
- *High operational reliability*
- *High load carrying capacity*

Bearing types

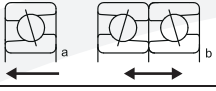
In various gearbox construction are used all types of ball and roller bearings.
The characteristics and their suitability for the different requirements are listed in the table below.

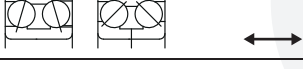
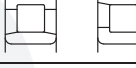
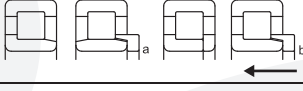
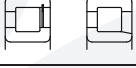
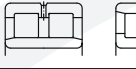
Bearing types and their characteristics

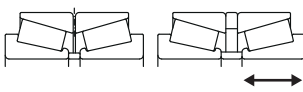
● - excellent ◐ - poor ◑ - good ○ - unsuitable ◒ - fair <i>Purely axial load</i> ← - single direction ↔ - double direction		PURELY RADIAL LOAD	PURELY AXIAL LOAD	COMBINED LOAD	MOMENT LOAD	QUIET RUNNING	HIGH SPEED	HIGH STIFFNESS	COMPENSATION OF MISALIGNMENT	LOW FRICTION	LOCATED BEARING	NON-LOCATED BEARING
Deep groove ball bearings		◑	◑	◑	◑	●	●	◑	●	◑	◑	◑
Self-aligning ball bearings		◑	◑	◑	○	◑	◑	●	◑	◑	◑	◑
Angular contact ball bearings	- single row 	◑	◑	◑	◑	◑	◑	○	◑	●	○	○
- high precision		◑	◑	◑	◑	●	●	○	◑	●	●	◑
- double rows		◑	◑	◑	◑	◑	◑	○	◑	◑	◑	◑
Cylindrical roller bearings	- NU; N 	●	○	○	○	◑	●	◑	◑	◑	○	○
- NJ, NU+HJ, NUP, NJ+HJ		●	◑	◑	○	◑	●	◑	◑	◑	◑	◑
- NCF, NJ23VH		●	◑	◑	○	◑	◑	◑	◑	◑	◑	◑
- NNU, NN		●	○	○	○	◑	●	○	◑	○	○	●
Spherical roller bearings		●	◑	◑	○	◑	◑	●	◑	◑	◑	◑
Tapered roller bearings	- single row 	●	◑	●	◑	◑	◑	◑	◑	◑	◑	○
- double row, paired		●	◑	●	◑	◑	◑	○	◑	●	○	○

Our products for the most popular types of gearboxes:

STANDARD BEARINGS

Deep groove ball bearings

Size range: 50 mm ÷ 320 mm (outer diameter)

They can carry combined loads in considerable quantities ($F_a < 0.25 F_r$)

- Suitable for high speeds
- Because of their narrow tolerance their fixing precisions are relatively high
- Low-noise operation because of low inner frictions.

These bearings are suitable for geared motors, planetary gears, worm and spur wheels etc.



Angular contact ball bearings

Size range: 50 mm ÷ 320 mm (outer diameter)

- Due to their internal design these bearings can withstand high radial-axial loads and reach high speeds
- Bearing design can be one directional thrust, double directional thrust, double row, double row maximum capacity angular, duplex thrust, and four-pointed contact
- They are suitable for application which requires high accuracy and good high-speed performance.



Cylindrical roller bearings

Size range: 30 mm ÷ 950 mm (outer diameter)

These bearings are ideal bearing types as floating bearings:

- They can carry high loads; if they operate only under radial loads they will have perfect performance
 - Noise level is relatively low even if reached high speeds
 - Resistant against imbalanced loads
 - Mounting and dismounting is simple due to lack of the shoulder.
- They are suitable in planetary, spur and helical gears.



Spherical roller bearings

Size range: 80 mm ÷ 620 mm (outer diameter)

- Can carry the heaviest radial loads
- Resistant against reversible and imbalanced loads
- Can compensate shaft misalignments from 0.5° up to 3°
- Can successfully be used as floating bearings
- Easy mounting operation of bearings with tapered bore, with tight fitting and proper clearance after mounting.

These bearings are suitable for high loads in planetary gears and spur gears.



Tapered roller bearings

Size range: 50 mm ÷ 360 mm (outer diameter)

- They are bearings that can take large axial forces as well as being able to sustain large radial force
- These bearings are used in back-to-back pairs so that axial force can be supported equally in either direction
- They support medium speeds

These bearings are mainly used in planetary, worm and spur gears, etc.



Thrust ball bearings - Single direction

Size range: 24 mm ÷ 665 mm (outer diameter)

- They are bearings that can take large axial forces as well as being able to sustain large radial force
- These bearings are used in back-to-back pairs so that axial force can be supported equally in either direction
- They support medium speeds

These bearings are mainly used in planetary, worm and spur gears, etc.



Thrust ball bearings - Double direction Size range: 32 mm ÷ 240 mm (outer diameter)

- They are suitable for moderate axial load in both direction; do not take radial load
 - Suitable for low to medium operating speeds
 - They require minimum axial loads for their optimum function.
- These bearings are used in machines tool gearboxes and other application.



Our solutions for special requirements

Bearing type **NNF... VS094FW99A-2RSR** with black oxide treatment

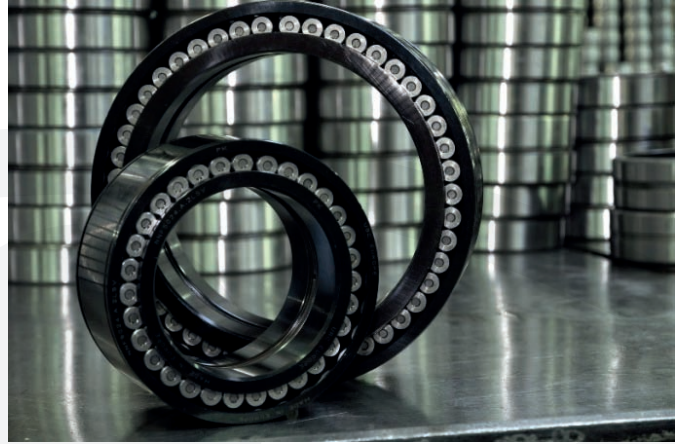
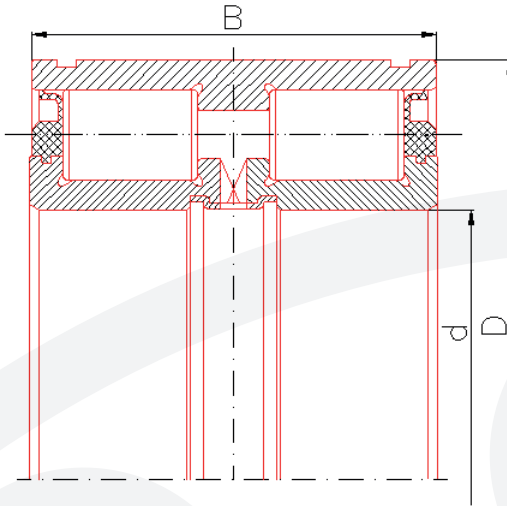

NNF Type (rings are black oxide)

Application: Wind Turbines gearboxes

Black oxide treatment offers the following benefits:

- reduced hydrogen permeation in the bearing steel;
- slight improvement of corrosion protection;
- reduced friction and wear;
- minor dimensional changes;
- good lubrication characteristics;
- reduction of chemical attack from aggressive oil additives on the bearing steel;
- reduced maintenance costs.

Full complement cylindrical roller bearings series 604533...

Bearing was developed according to application requirements. This bearing is a special cylindrical roller bearing single row, without cage with black oxide treatment.

Application: Planetary shaft for turbines gearbox.

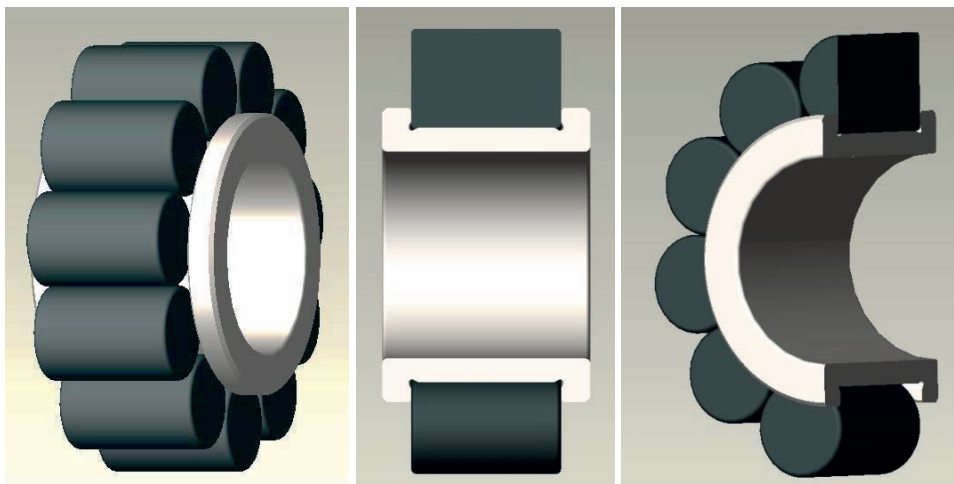

Tandem Bearings (2 rows and 3 rows)

These bearings offer the optimum solution of the following requirements:

- Limited radial space
- High axial force
- Long operating life
- Low frictional power

Application: Extruder gearboxes

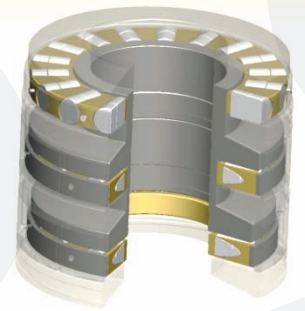
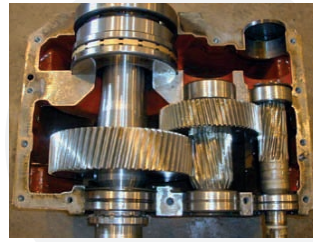

Four-row cylindrical roller bearings

These bearings are designed for extremely high radial load capacity with case-carburized steel materials for rings and rollers maximize resistance to shock, wear and debris. Optimized internal design and improved surface quality extended the service life of bearing.

Application: Planetary gearboxes

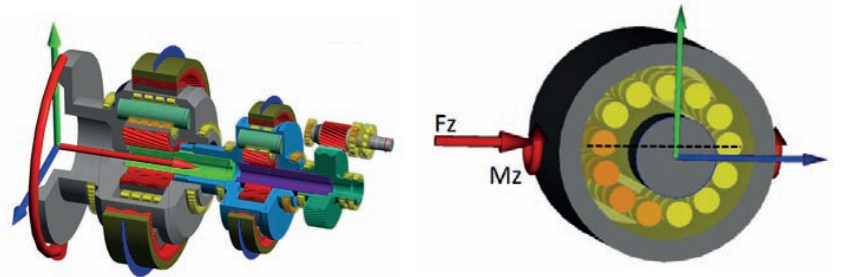
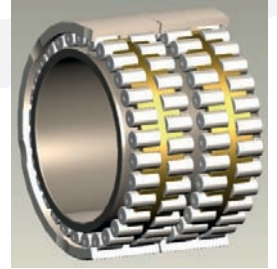

Research and development

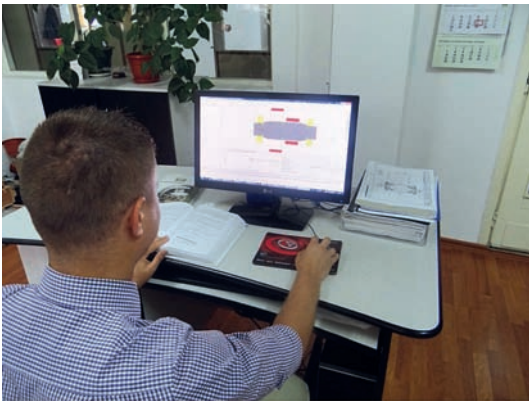

URB Company with over 60 years experience in designing bearings has the ability to continuously develop new products and services that improve our clients products.

Our engineers collaborate with customer technical team to select the best bearing solution in different application considered numerous influencing features for determining bearing life. The specialists in design and service successfully use specialized simulation programs to improve continuously the standards and customized bearings according to customer requirements. **Bearing Analysis Software** allows the calculation of bearing load distribution and bearing life according ISO/TS 16281 and is integrated in a shaft system calculation with additional

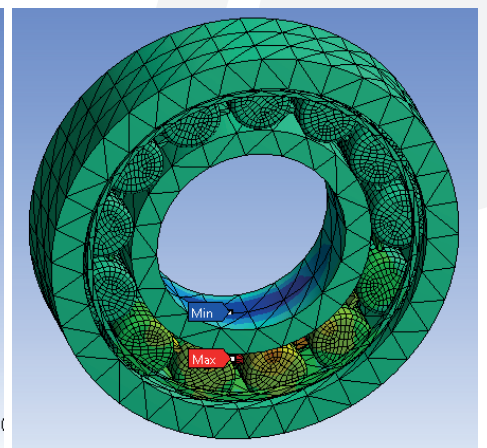
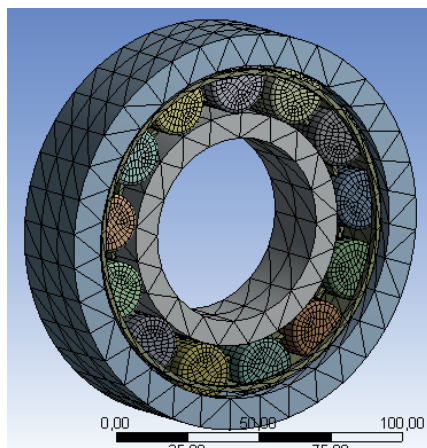
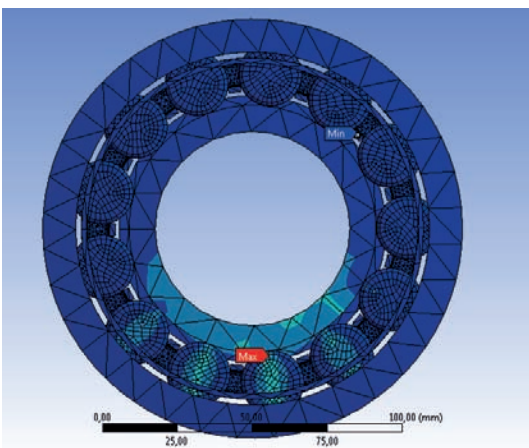

Geometry can be imported from all CAD software (Creo 3.0, CATIA V4, V5, Solid Edge, SolidWorks and Unigraphics etc).

possibilities like strength calculation for shafts, modal analysis and interfaces to gear calculation programs. In addition to the possibilities of the **Shaft Calculation** the system calculation allows to calculate shaft systems. Parallel and non parallel shafts and planetary stages can be coupled by gear connections. Natural frequencies can be calculated for the whole system and mode shapes are animated in the 3D view.

For structural analysis, including linear, nonlinear studies URB is using FEA (Finite Element Analysis) software.

The FEM (Finite Element Modeling) results provide reference for the design, optimization and failure analysis of rolling bearings and have practical engineering value.

Quality improvements

URB management is always oriented towards improving and optimizing control processes.

World class, state of the art measurement instruments, gauges and equipment's are used to ensure precision in product dimensions.



Ultra-fast mass spectrophotometry tester



*Crack detection
EDDY currents*



Micro hardness



Residual austenite

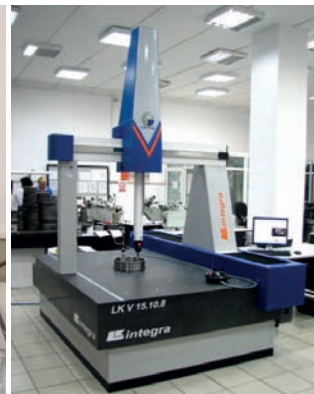

Universal measuring machine (3D)



Crack detection - Ultrasonic

Service

R&D Application and Service offers our customers a wide range of services:

- Technical support for new application development
- Calculations and computer simulations
- Bearing feature selection
- Information about correct bearing mounting, lubrication and maintenance to prevent premature failure
- Bearing training

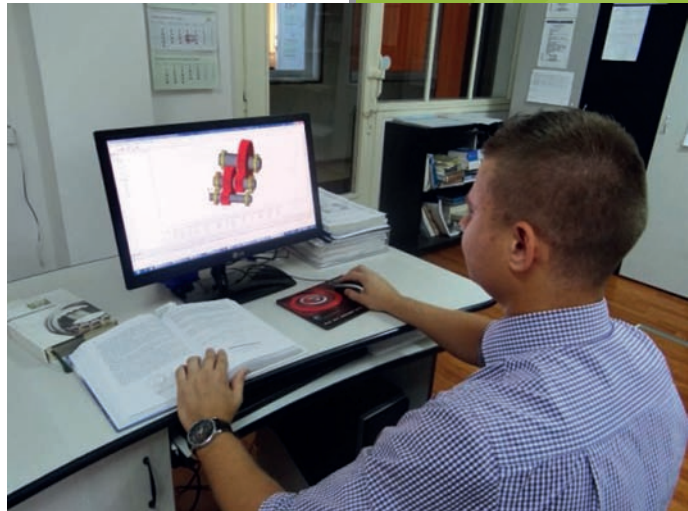
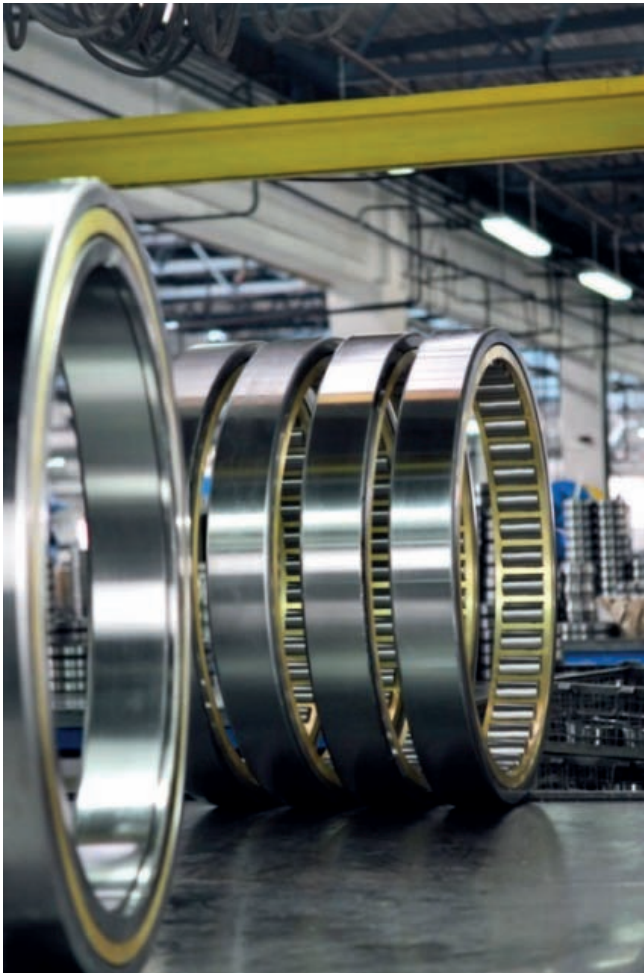

URB Company with over 60 years experience in designing bearings has the ability to continuously develop new products and services that improve our clients' products. For these investments in technology and specialists specialized software for the calculation and optimization of the existing construction, new materials, metal coatings have been made, increasing the lifetime of our products.

An important factor of quality is continuing design improvement (tapered ribs and roller end crowning to increase the axial load capacity), optimizes lubrication, increases loading capacity, minimizes edge stresses and use polymer cage.

The company was set-up on May 1953 and it has a long tradition in manufacturing of bearings over 60 years, being one of the important bearing manufactures in the Central and South-East Europe.

The key to success has been a consistent emphasis on maintaining the highest quality of our products and services and investment in research and development.

We include the respect for clients and the satisfaction of their needs among our fundamental principles. Therefore we tried to respond better to the market requirements by offering, besides the bearings with standardized shapes and sizes, a large range of non-standardized bearings, specific to various applications.